

ERGOLINE[®] Aktiv

HMV no.: 26.11.03.0001

Order Cost estimate

Name of the orderer Company

Order/Patient name Your order no.

Date Signature/Company stamp



ERGOLINE seat and back unit as aluminium version

- ▶ 2-, 3- or 4-mm version
- ▶ standard upholstery custom-made using the sandwich method for seat and back

Patient information

Name of the patient Date of birth male female

Diagnosis

Address of the patient

Med./Therap. Facility Name of the physician

Name of the therapist Health insurance provider

- | | |
|--|---|
| <input type="checkbox"/> Prescription enclosed | <input type="checkbox"/> Prescription to follow |
| <input type="checkbox"/> Therapeutic evaluation sheet enclosed | <input type="checkbox"/> Therapeutic evaluation sheet to follow |
| <input type="checkbox"/> Digital photos enclosed | <input type="checkbox"/> Digital photos to follow |

Legal guardian hereby grants his or her informed consent form for the compilation and use of the patient information within the framework of the services to be provided.

Date Signature

Medical Device Consultant at interco GmbH Medical Device Consultant at the health care facility

Health Care Facility / Official Stamp

By fax to: +49 (0) 2243/8807-29

By email to: info@interco.gmbh

Individual measurements

Please mark the appropriate box: Patient measurements Production sizes

Please enter the necessary measurements.

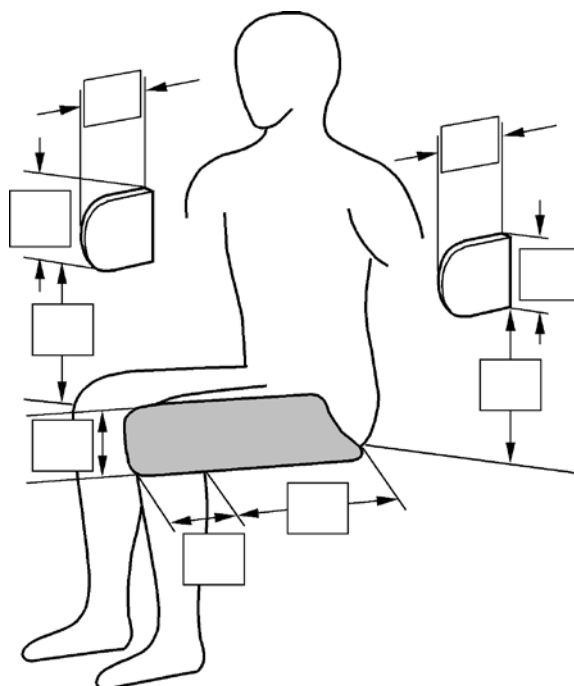
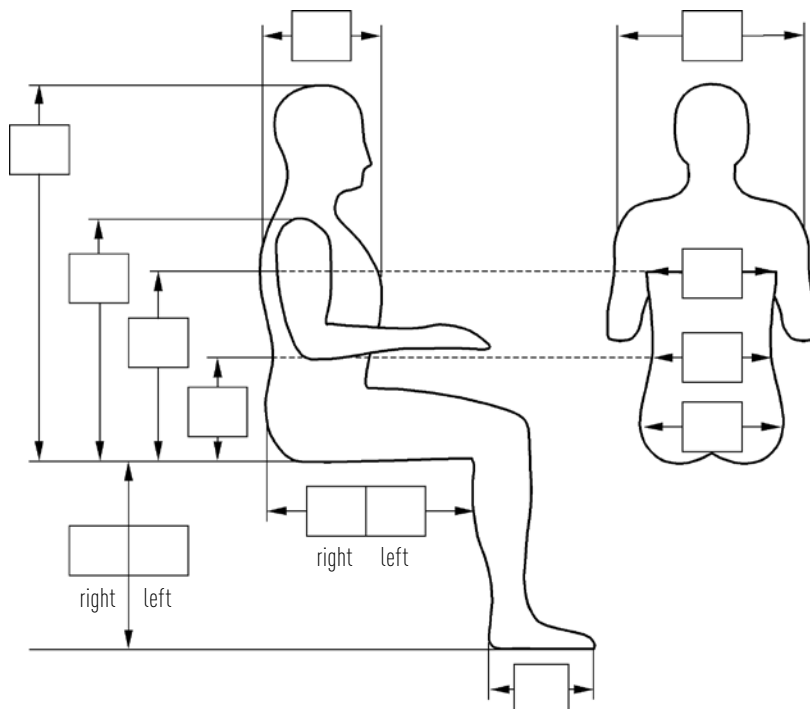

By fax to: +49 (0) 2243/8807-29

By email to: info@interco.gmbh

Individual measurements

Please enter the necessary measurements.

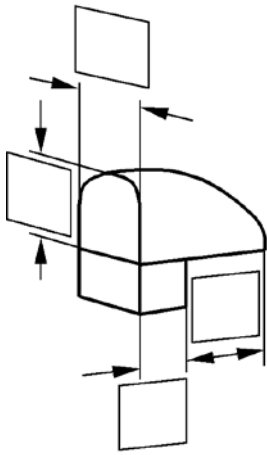

Abduction pommel

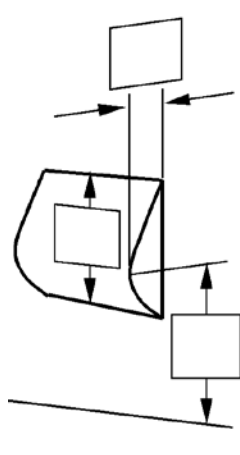

Lumbar spine support

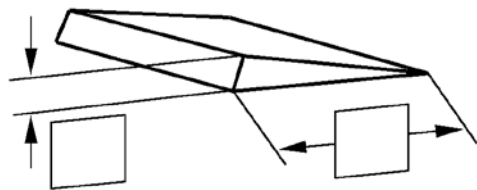

Seat wedge

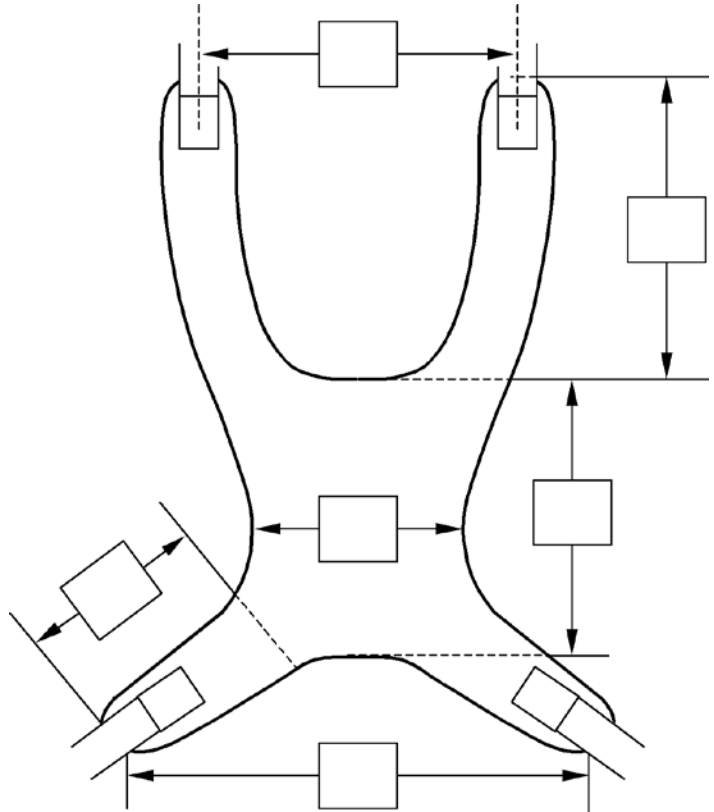

Chest harness

To produce the ERGOLINE we need the following datas:

Wheelchair model _____

Seatwidth of wheelchair _____

Seatdepth of wheelchair _____

Backheight of wheelchair _____

Max. outer width of seating system _____

Max. backheight of seating system _____

Fabric cover / Finish

Please enter the **fabric combination** of your choice here based on our **FABRIC COLLECTION** brochure:

By fax to: +49 (0) 2243/8807-29

By email to: info@interco.gmbh

Art. no.	Article name Article description Options	UNIT	Price *	Quantity
----------	--	------	---------	----------

Basic configuration

35001	ERGOLINE seat unit, 2-mm aluminum version without cover	ST	410.40 €	<input type="text"/>
35002-3	ERGOLINE seat unit, 3-mm aluminum version	ST	644.50 €	<input type="text"/>
35002-4	ERGOLINE seat unit, 4-mm aluminum version	ST	644.50 €	<input type="text"/>
36001	ERGOLINE - back unit, 2-mm version (straight version)	ST	558.70 €	<input type="text"/>
36002-3	ERGOLINE back unit, 3-mm version (straight version)	ST	772.80 €	<input type="text"/>
36002-4	ERGOLINE back unit, 4-mm version (straight version)	ST	668,80 €	<input type="text"/>
35030	ERGOLINE seat unit in 2-mm aluminum version for rounded back	ST	558,70 €	<input type="text"/>
35040	ERGOLINE seat unit in 4-mm aluminum version for rounded back	ST	772,80 €	<input type="text"/>
36030	ERGOLINE - back unit in 2-mm aluminum, rounded version	ST	741.60 €	<input type="text"/>
36040	ERGOLINE - back unit in 4-mm aluminum, rounded version	ST	957.90 €	<input type="text"/>
40210	Back hinges for connecting ERGOLINE seat and back unit	PA	63.60 €	<input type="text"/>
41031	Fixation of the ERGOLINE back unit at a fixed angle	ST	239.80 €	<input type="text"/>
	<input type="checkbox"/> 90° <input type="checkbox"/> 100° <input type="checkbox"/> 110° <input type="checkbox"/> 120° <input type="checkbox"/> other angle: _____			
41042	ERGOLINE seat unit, mountable using fastening plates	SA	185.10 €	<input type="text"/>
41041	ERGOLINE back unit, mountable using fastening plates	SA	185.10 €	<input type="text"/>
41045	Mounting unit for ERGOLINE back unit, rounded, on provided Aktiv wheelchair	SA	230.80 €	<input type="text"/>
40200r	ERGOLINE fastening strap for the back unit	ST	42.40 €	<input type="text"/>
40200s	ERGOLINE fastening strap for the seat unit	ST	42.40 €	<input type="text"/>
41035	Incorporate slots for strap	SA	75.80 €	<input type="text"/>

Upholstery

44330	Anatomical molding of the seat cushion	ST	186.20 €	<input type="text"/>
44331	Anatomical molding of the back cushion	ST	186.20 €	<input type="text"/>

By fax to: +49 (0) 2243/8807-29

By email to: info@interco.gmbh

Art. no.	Article name Article description Options	UNIT	Price *	Quantity
45011	Surcharge for upholstery with soft foam technique for SEAT only (molded seat)	ST	404.80 €	<input type="text"/>
45012	Surcharge for upholstery with soft foam technique for BACK only (molded back)	ST	404.80 €	<input type="text"/>
34600	Soft-Orthese for the seat, CAM milled according to file	ST	444.90 €	<input type="text"/>
34601	Soft-Orthese for the back, CAM milled according to file	ST	444.90 €	<input type="text"/>
34603	Soft-Orthese in two parts for the seat and back, CAM milled according to file	ST	889.90 €	<input type="text"/>
45031	Upholstery for seat unit with relax foam <input type="checkbox"/> 1 cm thickness <input type="checkbox"/> 2 cm thickness	ST	94.80 €	<input type="text"/>
45032	Upholstery for back unit with relax foam <input type="checkbox"/> 1 cm thickness <input type="checkbox"/> 2 cm thickness	ST	94.80 €	<input type="text"/>
45035	Partial upholstery with pincore latex for seat and/or back unit	ST	118.20 €	<input type="text"/>
47011	Water-repellent coating for complete seat shell	ST	304.40 €	<input type="text"/>
47012	Water-repellent coating for seat unit	ST	152.80 €	<input type="text"/>
44340 44341	Seat wedge, integrated <input type="checkbox"/> integrated <input type="checkbox"/> with Velcro attachment	ST	127.10 €	<input type="text"/>
44342	Cover for seat wedge with Velcro attachment	ST	53.50 €	<input type="text"/>



Covers

60072N	Anti-decubitus cover for ERGOLINE seat unit without integrated soft foam molded seat, fabric, spacer fabric or synthetic leather version	ST	165.00 €	<input type="text"/>
60075N	Anti-decubitus cover for ERGOLINE seat unit with integrated soft foam molded seat, fabric, spacer fabric or synthetic leather version	ST	186.20 €	<input type="text"/>
60062N	Anti-decubitus cover for ERGOLINE back unit without integrated soft foam molded seat, fabric, spacer fabric or synthetic leather version	ST	165.00 €	<input type="text"/>
60065N	Anti-decubitus cover for ERGOLINE back unit with integrated soft foam molded seat, fabric, spacer fabric or synthetic leather version	ST	186.20 €	<input type="text"/>
60077N	Anti-decubitus cover for ERGOLINE seat unit without integrated soft foam molded seat, fabric, spacer fabric or synthetic leather version, seat plate easily removable using zipper, includes replacement panel	ST	341.20 €	<input type="text"/>
60076N	Anti-decubitus cover for ERGOLINE seat unit with integrated soft foam molded seat, fabric, spacer fabric or synthetic leather version, seat plate easily removable using zipper, includes replacement panel	ST	297.70 €	<input type="text"/>
60078N	Anti-decubitus cover for ERGOLINE back unit without integrated soft foam molded seat, fabric, spacer fabric or synthetic leather version, seat plate easily removable using zipper, includes replacement panel	ST	297.70 €	<input type="text"/>
60079N	Anti-decubitus cover for ERGOLINE back unit with integrated soft foam molded seat, fabric, spacer fabric or synthetic leather version, seat plate easily removable using zipper, includes replacement panel	ST	341.20 €	<input type="text"/>

By fax to: +49 (0) 2243/8807-29

By email to: info@interco.gmbh

Art. no.	Article name Article description Options	UNIT	Price *	Quantity
60067	Fabric panel, attachable with Velcro, for ERGOLINE seat, pulled around the front edge	ST	111.00 €	<input type="text"/>
60055N	Surcharge for seat cover, attachable with Velcro to the wheelchair seat covering	ST	49.10 €	<input type="text"/>
60056N	Surcharge for back cover, attachable with Velcro to the wheelchair back covering	ST	49.10 €	<input type="text"/>
47016-r	Synthetic leather or Supra Tex reinforcement for back cover	ST	80.30 €	<input type="text"/>
47016-rfp	Synthetic leather or Supra Tex reinforcement for lateral side supports	ST	80.30 €	<input type="text"/>



Head

43020	Head rest holder, angled model	ST	108.20 €	<input type="text"/>		
43022	Head rest holder, straight model	ST	91.40 €	<input type="text"/>		
43021	Head rest holder with continuous angle adjustment	ST	179.50 €	<input type="text"/>		
43046	ALULINE head rest bracket, fixed model,	ST	268.70 €	<input type="text"/>		
43048	includes 1 x ALULINE universal bracket and support block					
		<input type="checkbox"/>	with one fastening element			
		<input type="checkbox"/>	with two fastening elements			
43049	ALULINE head rest bracket, laterally adjustable model, with one fastening element and support block, includes 1 x ALULINE universal bracket	ST	370.20 €	<input type="text"/>		
43050	ALULINE head rest bracket with depth adjustment option	ST	329.00 €	<input type="text"/>		
43056	ALULINE head rest bracket, fixed model, for head rests made of PU, compatible with ball and socket system	ST	298.90 €	<input type="text"/>		
43058	with ball and socket system and support block, includes 1 x ALULINE universal bracket					
		<input type="checkbox"/>	with one fastening element			
		<input type="checkbox"/>	with two fastening elements			
43023	Head rest depth adjustment	ST	81.40 €	<input type="text"/>		
43010	Standard head rest cushion with black synthetic leather cover	ST	141.60 €	<input type="text"/>		
					<input type="checkbox"/>	size 0
					<input type="checkbox"/>	size 1
		<input type="checkbox"/>	size 2			
43011	Head rest cushion, shell-shaped, with black synthetic leather cover	ST	141.60 €	<input type="text"/>		
					<input type="checkbox"/>	size 0
					<input type="checkbox"/>	size 1
		<input type="checkbox"/>	size 2			
43015	Fabric head rest cover for standard or shell-shaped head rest in addition to synthetic leather cover, easily removable using zipper	ST	73.60 €	<input type="text"/>		
43016	Real lamb skin cover for head rest (in addition to synthetic leather cover)	ST	100.40 €	<input type="text"/>		
43017	Head rest cushion with lateral guides, made of PU, compatible with ball and socket system	ST	226.37 €	<input type="text"/>		
					<input type="checkbox"/>	size 1
		<input type="checkbox"/>	size 2			
43018	Head rest cushion, shell-shaped, made of PU, compatible with ball and socket system	ST	226.40 €	<input type="text"/>		
					<input type="checkbox"/>	size 1
					<input type="checkbox"/>	size 2
		<input type="checkbox"/>	size 3			

By fax to: +49 (0) 2243/8807-29

By email to: info@interco.gmbh

Art. no.	Article name Article description Options	UNIT	Price *	Quantity
43013	Head rest cushion, individually customized version without cover	ST	273.20 €	<input type="text"/>
43015-SA	Fabric head rest for head rest in SA in addition to synthetic leather cover, easily removable using zipper	ST	100.40 €	<input type="text"/>



Upper body

44210	Lateral side support, right/left, fixed version	ST	142.70 €	<input type="text"/>		
44250	Lateral side support, height- and width-adjustable	ST	322.30 €	<input type="text"/>		
60081	Cover for lateral side supports	PA	91.40 €	<input type="text"/>		
44300	Lumbar spine support, integrated	ST	71.40 €	<input type="text"/>		
44301	Lumbar spine support, with Velcro attachment, without cover	ST	95.90 €	<input type="text"/>		
44302	Cover for lumbar spine support, with Velcro attachment	ST	53.50 €	<input type="text"/>		
44110u	Chest belt with deflection roller	<input type="checkbox"/> synthetic leather <input type="checkbox"/> neoprene	ST	89.20 €	<input type="text"/>	
44114	Chest belt, basic version (with Velcro attachment)	<input type="checkbox"/> made of synthetic leather <input type="checkbox"/> made of neoprene	<input type="checkbox"/> size 1 <input type="checkbox"/> size 2 <input type="checkbox"/> size 3	ST	137.20 €	<input type="text"/>
44115	Chest belt with flap	<input type="checkbox"/> made of synthetic leather <input type="checkbox"/> made of neoprene	<input type="checkbox"/> size 1 <input type="checkbox"/> size 2 <input type="checkbox"/> size 3	ST	155.00 €	<input type="text"/>
47130	Standard RV chest harness with push-in buckle, 25 mm, lock-stitched straps on the shoulders and zipper in the middle (includes clip buckle with fastening tab for mounting on seat shells)	<input type="checkbox"/> for boys <input type="checkbox"/> for girls <input type="checkbox"/> size 1 <input type="checkbox"/> size 2 <input type="checkbox"/> size 3 <input type="checkbox"/> size 4	<input type="checkbox"/> spacer fabrics <input type="checkbox"/> synthetic leather <input type="checkbox"/> neoprene	ST	214.10 € 189.60 € 281.00 €	<input type="text"/>
47131	VARIO chest harness with twist-lock at the pelvis and push-in buckles on the upper shoulder straps (includes clip buckle with fastening tab for mounting on seat shells)	<input type="checkbox"/> for boys <input type="checkbox"/> for girls <input type="checkbox"/> size 1 <input type="checkbox"/> size 2 <input type="checkbox"/> size 3 <input type="checkbox"/> size 4	<input type="checkbox"/> spacer fabrics <input type="checkbox"/> synthetic leather <input type="checkbox"/> neoprene	ST	220.80 € 196.30 € 281.00 €	<input type="text"/>
47132	REMOVABLE chest harness with removable upper straps with push-in clasp and push-in clasps at the pelvis	<input type="checkbox"/> for boys <input type="checkbox"/> for girls <input type="checkbox"/> size 1 <input type="checkbox"/> size 2 <input type="checkbox"/> size 3 <input type="checkbox"/> size 4	<input type="checkbox"/> spacer fabrics <input type="checkbox"/> synthetic leather <input type="checkbox"/> neoprene	ST	214.10 € 196.30 € 281.00 €	<input type="text"/>

By fax to: +49 (0) 2243/8807-29

By email to: info@interco.gmbh

Art. no.	Article name Article description	Options	UNIT	Price *	Quantity
47133	Standard chest harness with push-in buckle, 25 mm, lock-stitched straps on the shoulders (includes clip buckle with fastening tab for mounting on seat shells)	<input type="checkbox"/> for boys <input type="checkbox"/> for girls <input type="checkbox"/> size 1 <input type="checkbox"/> size 2 <input type="checkbox"/> size 3 <input type="checkbox"/> size 4	ST	209.60 € 161.70 € 267.60 €	<input type="text"/>
47200	Strap guide plates (includes clip buckle compatible with straps) for mounting on the edges of the seat shell, used to guide upper shoulder strap and enable continuous height adjustment		SA	65.80 €	<input type="text"/>
					
Pelvis					
44040	Adduction guides		ST	130.50 €	<input type="text"/>
44010	Abduction pommel without cover, adjustable and attachable		ST	170.60 €	<input type="text"/>
44011	Abduction pommel, swing-away, without cover		ST	248.70 €	<input type="text"/>
44020	Abduction pommel, integrated, including cover		ST	94.80 €	<input type="text"/>
44025	Cover for abduction pommel		ST	49.10 €	<input type="text"/>
44170u 44170u	Hip belt with deflection roller	<input type="checkbox"/> black synthetic leather <input type="checkbox"/> neoprene	ST	90.30 €	<input type="text"/>
44175-1	2-point hip belt, size 1 with neoprene cushion and small plastic press buckle with one pull		ST	179.50 €	<input type="text"/>
44175-2 44175-3	2-point hip belt with neoprene cushion and large plastic press buckle with one pull	<input type="checkbox"/> size 2 <input type="checkbox"/> size 3	ST	179.50 €	<input type="text"/>
44176-1	4-point hip belt, size 1, with neoprene cushion and small plastic press buckle with one pull		ST	190.70 €	<input type="text"/>
44176-2 44176-3	4-point hip belt, with neoprene cushion and large plastic press buckle with one pull	<input type="checkbox"/> size 2 <input type="checkbox"/> size 3	ST	190.70 €	<input type="text"/>
44177	2-point hip belt with neoprene cushion with two pulls	<input type="checkbox"/> size 1 <input type="checkbox"/> size 2 <input type="checkbox"/> size 3	ST	184.00 €	<input type="text"/>
44178	4-point hip belt with neoprene cushion with two pulls	<input type="checkbox"/> size 1 <input type="checkbox"/> size 2 <input type="checkbox"/> size 3	ST	195.10 €	<input type="text"/>

By fax to: +49 (0) 2243/8807-29

By email to: info@interco.gmbh

Art. no.	Article name Article description Options	UNIT	Price *	Quantity
44046 44047 44048 44049	PELVI-LOCK 3DS pelvis retraction belt with toothed belt and buckle for seat shells with flexible belt strap fastener	ST	304.40 €	<input type="text"/>
	<input type="checkbox"/> size XS (SB=16-24 cm) <input type="checkbox"/> size S (SB=20-32 cm) <input type="checkbox"/> size M (SB=30-40 cm) <input type="checkbox"/> size L (SB=36-46 cm)			
44050 44051 44052 44053	PELVI-LOCK 3DA pelvis retraction belt with toothed belt and concealed buckle for high traction forces for seat shells with rigid plastic belt strap fastener	ST	316.70 €	<input type="text"/>
	<input type="checkbox"/> size XS (SB=16-24 cm) <input type="checkbox"/> size S (SB=20-32 cm) <input type="checkbox"/> size M (SB=30-40 cm) <input type="checkbox"/> size L (SB=36-46 cm)			
44054 44055 44056 44057	PELVI-LOCK 3DAS pelvis retraction belt with toothed belt and concealed buckle for high traction forces for seat shells with flexible belt strap fastener	ST	316.70 €	<input type="text"/>
	<input type="checkbox"/> size XS (SB=16-24 cm) <input type="checkbox"/> size S (SB=20-32 cm) <input type="checkbox"/> size M (SB=30-40 cm) <input type="checkbox"/> size L (SB=36-46 cm)			
44061 44062 44063 44064	PELVI-LOCK 3DB pelvis retraction belt with toothed belt and red ratchet buckle for seat shells with rigid plastic belt strap	ST	304.40 €	<input type="text"/>
	<input type="checkbox"/> size XS (SB=16-24 cm) <input type="checkbox"/> size S (SB=20-32 cm) <input type="checkbox"/> size M (SB=30-40 cm) <input type="checkbox"/> size L (SB=36-46 cm)			
<div style="display: flex; justify-content: flex-end; align-items: center;">  </div>				
Lower extremities				
46410	Foot straps with hook and loop fastener with padded instep	PA	35.70 €	<input type="text"/>
46412	Foot straps with deflection roller and padded instep with hook and loop fastener	PA	89.20 €	<input type="text"/>
46419	Foot straps with incremental adjustment and padded instep	PA	113.70 €	<input type="text"/>
46420	Foot straps with clip buckle and padded instep	PA	113.70 €	<input type="text"/>
46414	Foot gaiters without forefoot restraint made of neoprene	PA	165.00 €	<input type="text"/>
	<input type="checkbox"/> size 1 <input type="checkbox"/> size 2 <input type="checkbox"/> size 3			
46416	Foot gaiters with forefoot restraint made of neoprene	PA	197.40 €	<input type="text"/>
	<input type="checkbox"/> size 1 <input type="checkbox"/> size 2 <input type="checkbox"/> size 3			

By fax to: +49 (0) 2243/8807-29

By email to: info@interco.gmbh

Art. no.	Article name	Article description	Options	UNIT	Price *	Quantity
----------	--------------	---------------------	---------	------	---------	----------

Total	<input type="text"/>
plus statutory VAT	<input type="text"/>
Final total	<input type="text"/>

Notes

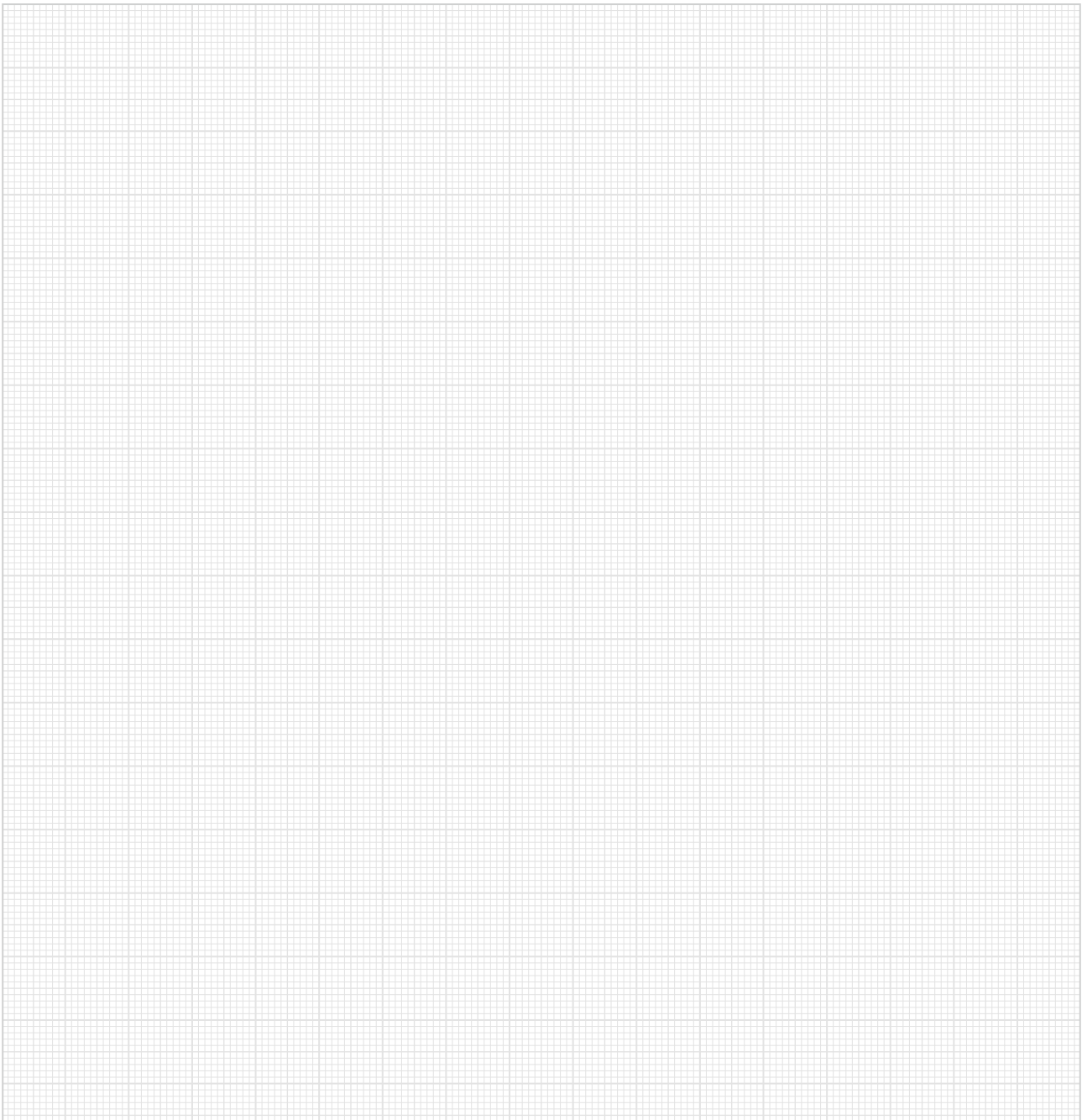

By fax to: +49 (0) 2243/8807-29

By email to: info@interco.gmbh